

# Chip trimmer potentiometers

## MVR32

### ●Features

- 1) Superb solderability thanks to extra soldering electrode.
- 2) Close match between wiper and resistive element reduces wiper noise.
- 3) Mounting can be automated by using a carrier tape.
- 4) Extremely thin dimensions and light weight facilitate miniaturization of equipment.
- 5) Two-digit markings used to indicate resistance.
- 6) Special screwdriver (AD1804) available separately.
- 7) ROHM resistors have approved ISO-9001 certification. Design and specifications are subject to change without notice.  
Carefully check the specification sheet before using or ordering it.

### ●Ratings

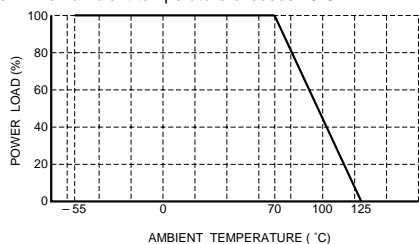
Item	Conditions	Specifications
Rated power	<p>Power must be derated according to the power derating curve in Figure 1 when ambient temperature exceeds 70°C.</p>  <p style="text-align: center;">Fig.1</p>	0.1W (1 / 10W) / element at 70°C
Rated voltage	<p>The voltage rating is calculated by the following equation. If the value obtained exceeds the maximum operating voltage, the voltage rating is equal to the maximum operating voltage.</p> $E = \sqrt{P \times R}$ <p style="margin-left: 40px;">E : Rated voltage (V) P : Rated power (W) R : Nominal resistance (Ω)</p>	Max. operating voltage : 50V
Nominal total resistance range		100 ~ 1MΩ <small>(recommended resistance value : E3 series) (applicable resistance value : E3 series)</small>
Total resistance tolerance		±25%
Resistance variation		B (linear) characteristics
Effective rotation angle		250±20°
Operating temperature		-55°C ~ +125°C
Reactive variable range	Rotational angle, both ends	within 10% (R>150Ω) within 20% (R≤150Ω)

- Before using components in circuits where they will be exposed to transients such as pulse loads (short-duration, high-level loads), be certain to evaluate the component in the mounted state. In addition, the reliability and performance of this component cannot be guaranteed if it is used with a steady state voltage that is greater than its rated voltage.
- The remainder of flux may negatively affect product performance and reliability. So please make sure to wash and remove flux completely washing.

## Resistors

## ●Characteristics

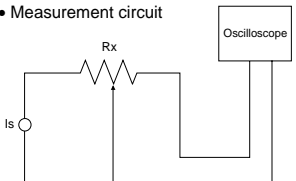
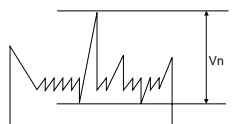
Characteristics	Specifications	Test method (JIS C 5261)
DC total resistance	Within $\pm 25\%$	JIS C 5261 5.1
Contact resistance rate	3% or less	JIS C 5261 5.9
Resistance change characteristics	B group OB	JIS C 5261 5.1 Voltage method
Residual resistance	$R < 1k\Omega$ 200 $\Omega$ or less $R \geq 1k\Omega$ Within 2% of total nominal resistance	JIS C 5261 5.1
Wiper noise	5% or less of total nominal resistance, within the effective rotational range	JIS C 5261 5.8 B method Rotational speed of approx. 10 cycles per minute (with one cycle defined as one round trip)  <ul style="list-style-type: none"> <li>• Measurement circuit</li> </ul>  <ul style="list-style-type: none"> <li>• Measurement waveform</li> </ul>  <p>Provided that the constant current has been set according to the following:  <math display="block">I_s : I_s = \frac{10}{R_x}</math> (When <math>R_x \leq 1k\Omega</math>, constant current is defined as <math>I_s = 10mA</math>)  <math>R_x</math> : Nominal resistance of semi-fixed test resistor.  <math>V_n</math> : Noise voltage  <math display="block">\text{Noise rate} = \frac{V_n}{I_s \times R_x} \times 100 (\%)</math></p>
Resistance temperature characteristics	$\pm 250ppm / ^\circ C$	JIS C 5261 5.3 +25 / -55 / +25 / +125 $^\circ C$
Resistance to dry heat	Total resistance change rate : $\pm (5.0\%+0.1\Omega)$ Constriction contact resistance rate: 8% or less	JIS C 5261 7.2 125 $^\circ C$ Test time : 1,000 ~ 1,048 hrs.
Temperature cycling	Total resistance change rate : $\pm (5.0\%+0.1\Omega)$ Constriction contact resistance rate: 8% or less	JIS C 5261 7.3 Test temperature: -55 $^\circ C$ ~ + 125 $^\circ C$ 100cyc.
Resistance to humidity (steady state)	Total resistance change rate : $\pm (5.0\%+0.1\Omega)$ Constriction contact resistance rate: 8% or less	JIS C 5261 7.4 60 $^\circ C$ , 95%RH Test time: 1,000 ~ 1,048 hrs.
Endurance (under load in damp environment)	Total resistance change rate : $\pm (5.0\%+0.1\Omega)$ Constriction contact resistance rate: 8% or less	JIS C 5261 7.6 Rated voltage (current) , 60 $^\circ C$ , 95%RH 1.5h : ON -0.5h : OFF Test time: 1,000 ~ 1,048 hrs.
Endurance (steady state)	Total resistance change rate : $\pm (5.0\%+0.1\Omega)$ Constriction contact resistance rate : 8% or less	JIS C 5261 7.7 Rated voltage (current) , 70 $^\circ C$ 1.5h : ON -0.5h : OFF Test time: 1,000 ~ 1,048 hrs.
Rotational torque	1.9 ~ 19.7mN $\cdot$ m (20 ~ 200gf $\cdot$ cm)	JIS C 5261 6.2
Endurance (wiper)	Total resistance change rate : Within $\pm 15\%$ Constriction contact resistance rate : 8% or less	JIS C 5261 7.8 After 20 rotations

Resistors

Characteristics	Specifications	Test method (JIS C 5261)
Terminal strength (compression)	Total resistance change rate : $\pm (3.0\%+0.1\Omega)$ There must be no mechanical damage.	JIS C 5261 6.5 Force (4.9N) is applied from three directions upon the middle of the sides of the sample on the surface being tested, as shown in the illustration on the left.
Terminal strength (bending)	Total resistance change rate : $\pm (3.0\%+0.1\Omega)$ There must be no mechanical damage.	JIS C 5261 6.5 Duration of pressure : $5\pm 1s$ Amount of bending : 3 mm
Resistance to soldering heat	Total resistance change rate: $\pm (3.0\%+0.1\Omega)$ Constriction contact resistance rate: 5% or less	JIS C 5261 6.7 Soldering conditions : $260\pm 5^\circ C$ Soldering time : $10\pm 1s$ .
Solderability	95% of terminal surface must be covered by new soldering, and there must be no soldering corrosion.	JIS C 5261 6.8 Flux : Rosin methanol or rosin isopropyl alcohol Solde r: H63A Soldering conditions : $235\pm 5^\circ C$ Soldering time : $2.0\pm 0.5s$ .

●External dimensions (Units : mm)

Part	Material
① Substrate	Alumina substrate (96% alumina or greater)
② Dielectric glaze	oxide dielectric glaze
③ Eyelet	Stainless steel + metal plating
④ Wiper	Stainless steel
⑤ Electrode	(Internal) Primary electrode with thick film of palladium-silver
⑥ Electrode	(External) Soldering tip
⑦ Protective film	Organic film

(Units : mm)

A	B	C	D	E	F	G	H	I
$3.0\pm 0.1$	$1.5\pm 0.1$	$1.5\pm 0.1$	$1.6\pm 0.1$	$1.0\pm 0.15$	$2.6\pm 0.1$	Max. 3.6	$1.9\pm 0.05$	$0.5\pm 0.05$
J	K	L	M	N	O	P	Q	
Max. 1.3	$1.15\pm 0.1$	$0.7\pm 0.1$	$0.18\pm 0.05$	$0.9\pm 0.1$	$0.35\pm 0.1$	Max. 0.65	Max. 1.1	

●Equivalent circuit

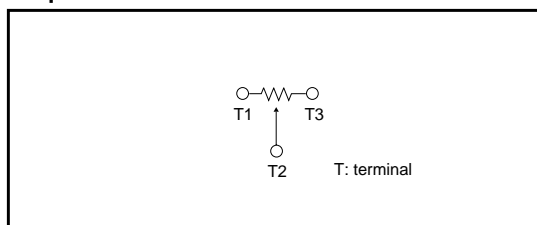

Resistors

●Packaging

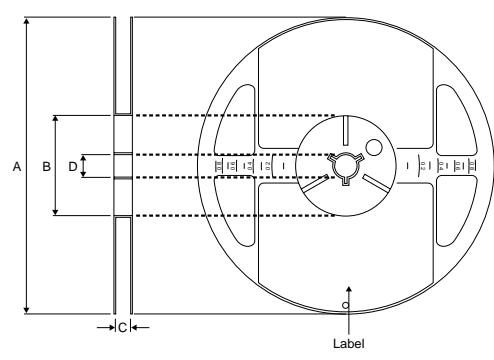
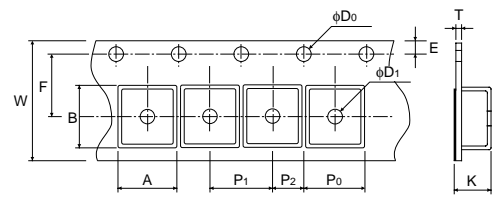
Reel	Taping																																				
 <p style="text-align: center;">EIAJ ET-7001 compliant</p> <p style="text-align: center;">(Units : mm)</p> <table border="1" style="margin-left: auto; margin-right: auto;"> <thead> <tr> <th>A</th> <th>B</th> <th>C</th> <th>D</th> </tr> </thead> <tbody> <tr> <td style="text-align: center;"><math>\phi 180</math></td> <td style="text-align: center;"><math>\phi 60</math></td> <td style="text-align: center;"><math>9 \pm 0.3</math></td> <td style="text-align: center;"><math>\phi 13 \pm 0.3</math></td> </tr> </tbody> </table>	A	B	C	D	$\phi 180$	$\phi 60$	$9 \pm 0.3$	$\phi 13 \pm 0.3$	 <p style="text-align: center;">(Units : mm)</p> <table border="1" style="margin-left: auto; margin-right: auto;"> <thead> <tr> <th>A</th> <th>B</th> <th>W</th> <th>F</th> <th>E</th> <th>P<sub>1</sub></th> <th>P<sub>2</sub></th> </tr> </thead> <tbody> <tr> <td style="text-align: center;"><math>3.3 \pm 0.2</math></td> <td style="text-align: center;"><math>3.8 \pm 0.2</math></td> <td style="text-align: center;"><math>8.0 \pm 0.2</math></td> <td style="text-align: center;"><math>3.5 \pm 0.05</math></td> <td style="text-align: center;"><math>1.75 \pm 0.1</math></td> <td style="text-align: center;"><math>4.0 \pm 0.1</math></td> <td style="text-align: center;"><math>2.0 \pm 0.05</math></td> </tr> <tr> <td style="text-align: center;">P<sub>0</sub></td> <td style="text-align: center;"><math>\phi D_0</math></td> <td style="text-align: center;">T</td> <td style="text-align: center;">K</td> <td style="text-align: center;"><math>\phi D_1</math></td> <td></td> <td></td> </tr> <tr> <td style="text-align: center;"><math>4.0 \pm 0.1</math></td> <td style="text-align: center;"><math>1.5^{+0.1}_0</math></td> <td style="text-align: center;">Max. 0.6</td> <td style="text-align: center;">Max. 2.5</td> <td style="text-align: center;">Min. 1.0</td> <td></td> <td></td> </tr> </tbody> </table>	A	B	W	F	E	P <sub>1</sub>	P <sub>2</sub>	$3.3 \pm 0.2$	$3.8 \pm 0.2$	$8.0 \pm 0.2$	$3.5 \pm 0.05$	$1.75 \pm 0.1$	$4.0 \pm 0.1$	$2.0 \pm 0.05$	P <sub>0</sub>	$\phi D_0$	T	K	$\phi D_1$			$4.0 \pm 0.1$	$1.5^{+0.1}_0$	Max. 0.6	Max. 2.5	Min. 1.0		
A	B	C	D																																		
$\phi 180$	$\phi 60$	$9 \pm 0.3$	$\phi 13 \pm 0.3$																																		
A	B	W	F	E	P <sub>1</sub>	P <sub>2</sub>																															
$3.3 \pm 0.2$	$3.8 \pm 0.2$	$8.0 \pm 0.2$	$3.5 \pm 0.05$	$1.75 \pm 0.1$	$4.0 \pm 0.1$	$2.0 \pm 0.05$																															
P <sub>0</sub>	$\phi D_0$	T	K	$\phi D_1$																																	
$4.0 \pm 0.1$	$1.5^{+0.1}_0$	Max. 0.6	Max. 2.5	Min. 1.0																																	

●Product designation

Part No.

M

V

R

3

2

H

X

B

R

N

Packaging / Processing specifications

Code	Part No.	Processing specifications	Packaging specifications	Packaging style	Standard ordering unit (pcs)
HXBR	MVR22 / 32 / 34	Reflow soldering	Taping	Embossed tape with reel	2000

Resistance tolerance

N | ±25%

Nominal resistance

3-digit IEC coding system

Resistors

●Recommended screwdriver for adjusting MVR resistors

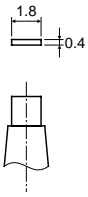
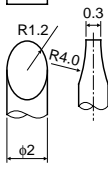
Model	Open, type 3	
	MVR	
Dimensions, configuration	Manual adjustment	Automatic adjustment
		
Commercially sold product [Maker]	AD1804 [Rohm] (see note) No.9000 (-) 1.8×30 [Vessel]	-

Note : Screwdriver specified by ROHM for adjustment of MVR chips (MVR32).

Product name	Tip size	Tip material	Main body material
AD1804	1.8×0.4	Zirconia	ABS resin

Sold in units of 20. Protective cap included.

(Units : mm)

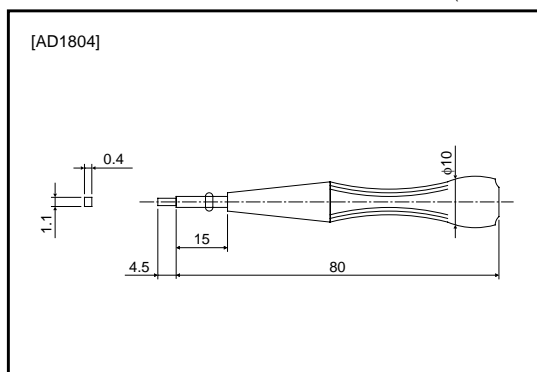

Resistors

●Dimensions (Units : mm)

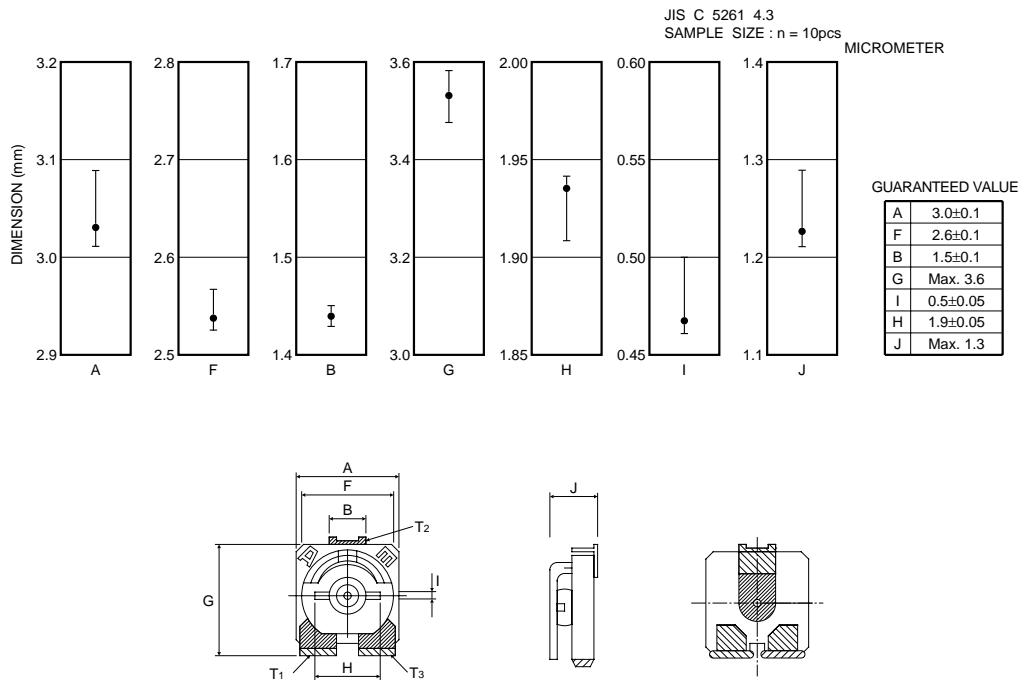

Fig.2 Dimensions

●Electrical characteristics

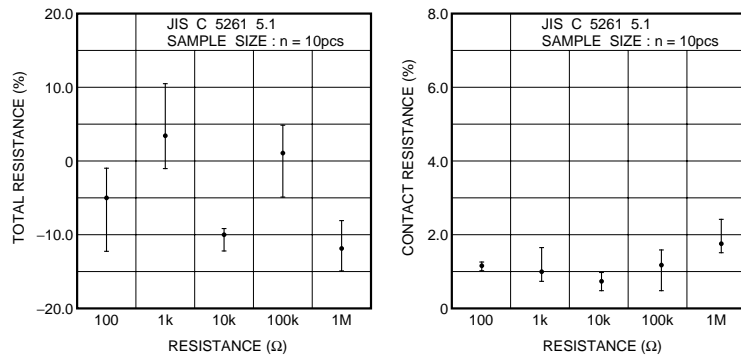

Fig.3 DC resistance : Total and contact

Resistors

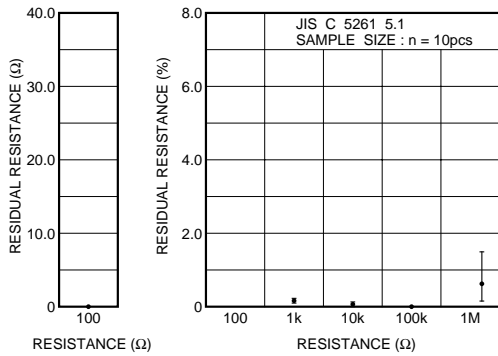

Fig.4 Residual resistance

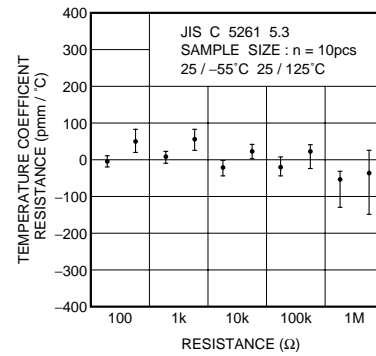

Fig.5 Resistance temperature characteristics

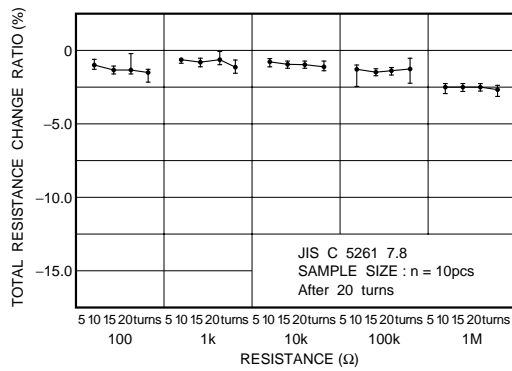

Fig.6-1 Endurance (wiper)

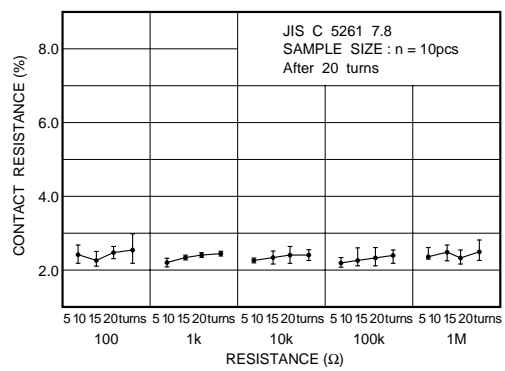

Fig.6-2 Endurance (wiper)

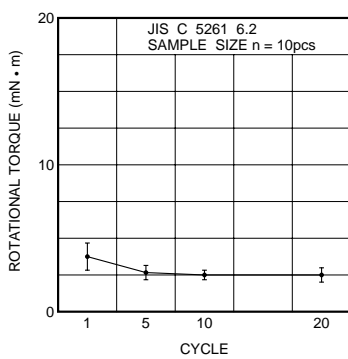

Fig.7 Rotational torque

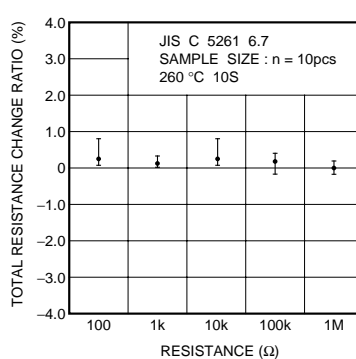
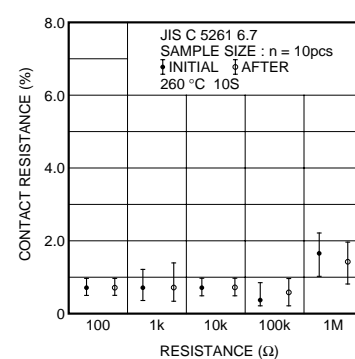

Fig.8 Resistance to soldering heat



Resistors

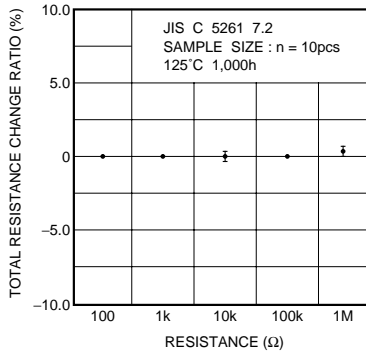

Fig.9 Resistance to dry heat

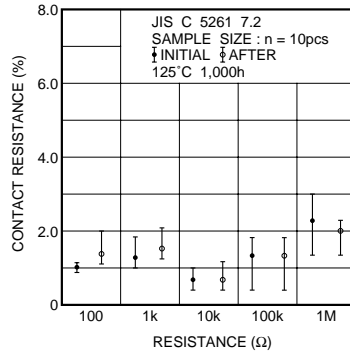

Fig.10-1 Temperature cycling

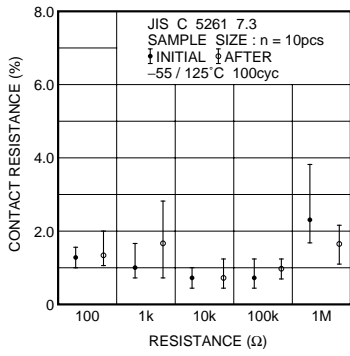
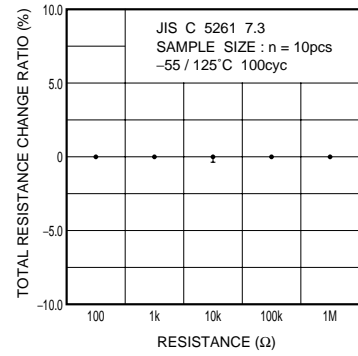

Fig.10-2 Temperature cycling

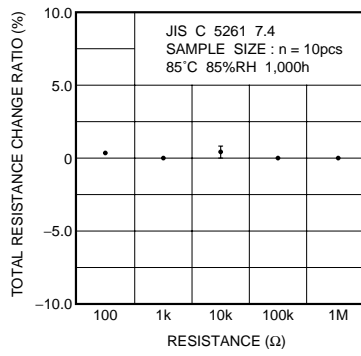

Fig.11 Resistance to humidity (steady state)

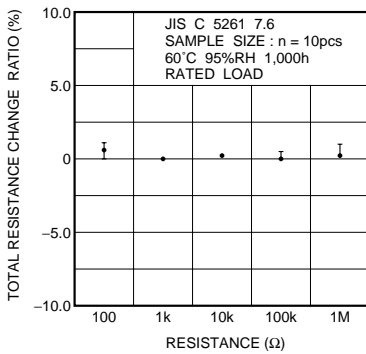
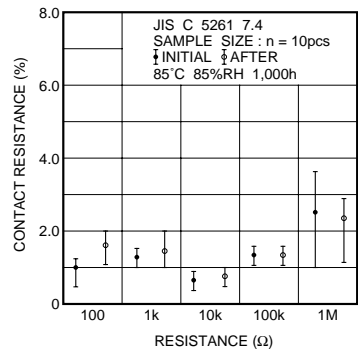

Fig.12 Endurance (Under load in damp environment)

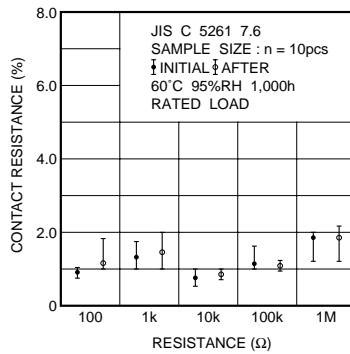
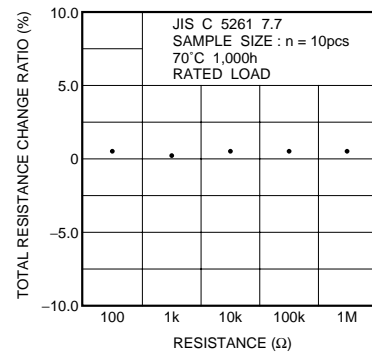

Fig.13-1 Endurance (rated load)





Resistors

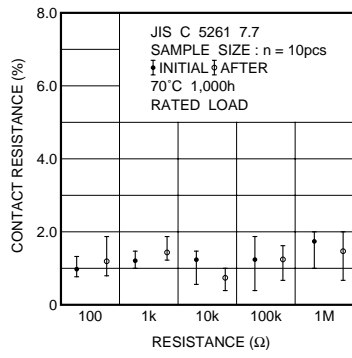

Fig.13-2 Endurance (rated load)

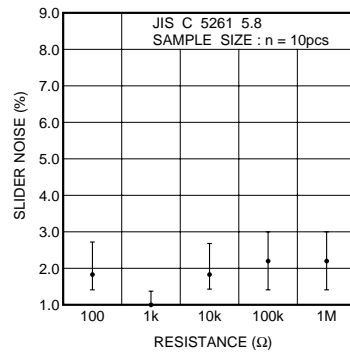

Fig.14 Wiper noise